

TAL 044

Low Voltage Alternator - 4 pole

Three-phase 70 to 200 kVA - 50 Hz / 88 to 250 kVA - 60 Hz
Dedicated single-phase 57 to 82 kVA - 50 Hz / 80 to 125 kVA - 60 Hz
Electrical and mechanical data

LEROY-SOMER[™]

Nidec
All for dreams

TAL 044 - Three-phase & Single-phase

The best of performance

Nidec Leroy-Somer TAL 044 alternator has been designed to offer you the best power generation performances. With its meticulous design and optimized architecture, the TAL 044 strikes the perfect balance between compactness, reliability, performance and longevity. Whatever your application, the TAL 044 will meet your needs and will adapt to all situations.

Standards

Nidec Leroy-Somer TAL 044 alternator meets all key international standards and regulations, including IEC 60034, NEMA MG 1.32-33, ISO 8528-3, CSA C22.2 n° 100-14 and UL 1446 (UL 1004 on request). Also compliant with IEC 61000-6-2, IEC 61000-6-3, IEC 61000-6-4, VDE 0875G, VDE 0875N and EN 55011, group 1 class A for European zone. Nidec Leroy-Somer TAL 044 alternator can be integrated in EC marked generator set, and bears EC, EAC and CMIM markings. It is designed, manufactured and marketed in an ISO 9001 and ISO 14001 quality assurance environment.

Electrical characteristics and performances

- Class H insulation
- Shunt excitation
- Low voltage winding:
 - Three-phase 50 Hz: 220V - 240V and 380V - 415V (440V)
 - 60 Hz: 208V - 240V and 380V - 480V
 - Single-phase 50 Hz: 230V
 - 60 Hz: 240V
- 4-terminal plates in 6-wire version
- Optimized performance

Excitation and regulation system

	Excitation system				Regulation options		
	AVR	SHUNT	AREP+ (option)	PMG (option)	UL _{C/US}	Remote voltage potentiometer	C.T. Current transformer for paralleling
Three-phase 6-wire	R120	Standard					
	R150	Option				√	
	R180		Standard	Standard		√	√
	D350	Option	Option	Option	√	√	√*
Three-phase 12-wire	R120	Standard					
	R250	Option			√	√	
	R180		Standard	Standard		√	√
	D350	Option	Option	Option	√	√	√*
Single-phase	R121	Standard				√	
	R251	Option			√	√	

*: only with AREP+ or PMG

Protection system and options

- Degree of protection: IP 23
- Complete winding protection for non-harsh environment with relative humidity ≤ 95%
- Options:
 - Three-phase 12-wire with 8-terminal plates
 - AREP+ or PMG excitation
 - UL_{C/US}
 - Customized painting (unpainted machine as standard)
 - Space heater
 - Flying leads
 - Droop kit for alternator paralleling
 - Dedicated single-phase
 - Stator sensors
 - Winding 8 optimized for three-phase 380V / 416V - 60Hz
 - Reinforced winding protection for harsh environments and relative humidity greater than 95% (system 2 - 4): for TAL 044 K apply a derating coefficient of 0.97

Mechanical construction

- Compact and rugged assembly to withstand engine vibrations
- Steel frame
- Aluminum flanges and shields
- Single-bearing design compatible with most diesel engines
- Greased for life bearings
- Direction of rotation: clockwise and counterclockwise without derating

Terminal box design

- Easy access to AVR and terminals
- Possibility of current transformer for parallel operation

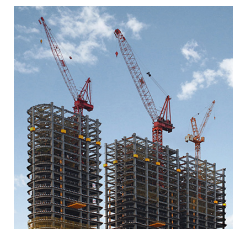

TAL 044 - Three-phase 70 to 200 kVA - 50 Hz / 88 to 250 kVA - 60 Hz

General characteristics

Insulation class	H	Excitation system 6-wire	SHUNT	AREP+ / PMG
Winding pitch	2/3 (wind.6S - 6-wire / wind.6 - 12-wire)	AVR type	R120	R180
Number of wires	6 (12 option)	Excitation system 12-wire (option)	SHUNT	AREP+ / PMG
Protection	IP 23	AVR type	R120	R180
Altitude	≤ 1000 m	Voltage regulation (**)	± 1 %	± 0.5 %
Overspeed	2250 R.P.M.	Total Harmonic Distortion THD (***) in no-load	< 2 %	
Air flow 50 Hz	0.29 m³/s	Total Harmonic Distortion THD (***) in linear load	< 5 %	
Air flow 60 Hz	0.34 m³/s	Waveform: NEMA = TIF (***)	< 50	
AREP+/PMG Short-circuit current = 2.7 I _n : 5 seconds (*)		Waveform: I.E.C. = FHT (***)	< 2%	

(*) D350: 10 seconds (**) Steady state (***) Total harmonic distortion between phases, no-load or on-load (non-distorting)

Ratings 50 Hz - 1500 R.P.M.

kVA / kW - P.F. = 0.8																				
Duty / T° C	Continuous / 40 °C					Continuous / 40 °C					Stand-by / 40 °C		Stand-by / 27 °C							
Class / T° K	H / 125° K					F / 105° K					H / 150° K		H / 163° K							
Phase	3 ph.			1 ph.		3 ph.			1 ph.		3 ph.		1 ph.							
Y	380V	400V	415V	440V		380V	400V	415V	440V		380V	400V	415V	440V		380V	400V	415V	440V	
Δ	220V	230V	240V		230V	220V	230V	240V		230V	220V	230V	240V		230V	220V	230V	240V		230V
YY (*)					200V					220V			200V			220V			220V	
ΔΔ (*)					230V					230V			230V			230V			230V	
TAL 044 A kVA	70	70	70	63	42	64	64	64	57	38	74	74	74	67	45	77	77	77	69	46
kW	56	56	56	50	33.5	51	51	51	46	30.5	59	59	59	54	36	62	62	62	55	37
TAL 044 B kVA	80	80	80	72	48	73	73	73	66	44	85	85	85	76	51	88	88	88	79	53
kW	64	64	64	58	38.5	58	58	58	53	35	68	68	68	61	41	70	70	70	63	42
TAL 044 C kVA	90	90	90	81	54	82	82	82	74	49	95	95	95	86	57	100	100	100	89	59
kW	72	72	72	65	43	66	66	66	59	39	76	76	76	69	46	80	80	80	71	47
TAL 044 D kVA	100	100	100	90	60	91	91	91	82	55	106	106	106	95	64	110	110	110	99	66
kW	80	80	80	72	48	73	73	73	66	44	85	85	85	76	51	88	88	88	79	53
TAL 044 E kVA	125	125	125	113	67	114	114	114	103	61	133	133	133	120	71	138	138	138	124	74
kW	100	100	100	90	54	91	91	91	82	49	106	106	106	96	57	110	110	110	99	59
TAL 044 H kVA	135	135	135	122	73	123	123	123	111	66	143	143	143	129	77	150	150	150	134	80
kW	108	108	108	98	58	98	98	98	89	53	114	114	114	103	62	120	120	120	107	64
TAL 044 J kVA	150	150	150	135	80	137	137	137	123	73	159	159	159	143	85	165	165	165	149	88
kW	120	120	120	108	64	110	110	110	98	58	127	127	127	114	68	132	132	132	119	70
TAL 044 K kVA	165	165	165	138	88	150	150	150	126	80	175	175	175	150	93	182	182	182	157	97
kW	132	132	132	110	70	120	120	120	101	64	140	140	140	120	74	146	146	146	126	78
TAL 044 L kVA	180	180	180	171	90	164	164	164	156	82	191	191	191	181	95	200	200	200	188	99
kW	144	144	144	137	72	131	131	131	125	66	153	153	153	145	76	160	160	160	150	79
TAL 044 M kVA	192	200	200	192	100	175	182	182	175	91	204	212	212	204	106	211	220	220	211	110
kW	154	160	160	154	80	140	146	146	140	73	163	170	170	163	85	169	176	176	169	88

(*) 12-wire option

Ratings 60 Hz - 1800 R.P.M.

kVA / kW - P.F. = 0.8																				
Duty / T° C	Continuous / 40 °C					Continuous / 40 °C					Stand-by / 40 °C		Stand-by / 27 °C							
Class / T° K	H / 125° K					F / 105° K					H / 150° K		H / 163° K							
Phase	3 ph.			1 ph.		3 ph.			1 ph.		3 ph.		1 ph.							
Y	380V	416V	440V	480V		380V	416V	440V	480V		380V	416V	440V	480V		380V	416V	440V	480V	
Δ	220V	240V		240V		220V	240V		240V		220V	240V		240V		220V	240V		240V	
YY (*)					240V					240V			208V			240V			240V	
ΔΔ (*)					240V					240V			240V			240V			240V	
TAL 044 A kVA	69	76	80	88	46	63	69	73	80	42	73	81	85	93	49	76	84	88	97	51
kW	55	61	64	70	37	50	55	58	64	33.5	58	65	68	74	39	61	67	70	78	41
TAL 044 B kVA	79	87	92	100	52	72	79	84	91	47	84	92	98	106	55	87	96	101	110	57
kW	63	70	74	80	42	58	63	67	73	37.5	67	74	78	85	44	70	77	81	88	46
TAL 044 C kVA	89	98	103	113	59	81	89	94	103	54	94	104	109	120	63	98	108	113	124	65
kW	71	78	82	90	47	65	71	75	82	43	75	83	87	96	50	78	86	90	99	52
TAL 044 D kVA	99	108	115	125	65	90	98	105	114	59	105	114	122	133	69	109	119	127	138	72
kW	79	86	92	100	52	72	78	84	91	47	84	91	98	106	55	87	95	102	110	58
TAL 044 E kVA	124	135	143	156	76	113	123	130	142	69	131	143	152	165	81	136	149	157	172	84
kW	99	108	114	125	61	90	98	104	114	55	105	114	122	132	65	109	119	126	138	67
TAL 044 H kVA	134	146	155	169	81	122	133	141	154	74	142	155	164	179	86	147	161	171	186	89
kW	107	117	124	135	65	98	106	113	123	59	114	124	131	143	69	118	129	137	149	71
TAL 044 J kVA	148	163	172	188	95	135	148	157	171	86	157	173	182	199	101	163	179	189	207	105
kW	118	130	138	150	76	108	118	126	137	69	126	138	146	159	81	130	143	151	166	84
TAL 044 K kVA	165	179	189	206	105	150	163	172	187	96	175	190	200	218	111	182	197	208	227	116
kW	132	143	151	165	84	120	130	138	150	77	140	152	160	174	89	146	158	166	182	93
TAL 044 L kVA	180	195	210	225	113	164	177	191	205	102	191	207	223	239	119	200	215	231	250	124
kW	144	156	168	180	90	131	142	153	164	82	153	166	178	191	95	160	172	185	200	99
TAL 044 M kVA	200	215	230	250	125	182	196	209	228	114	212	228	244	265	133	220	237	253	275	136
kW	160	172	184	200	100	146	157	167	182	91	170	182	195	212	106	176	190	202	220	109

(*) 12-wire option

Efficiencies 400 V - 50 Hz (— P.F.: 0.8) (--- P.F.: 1)

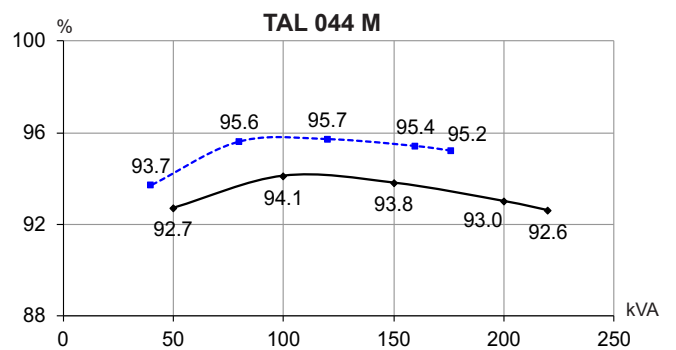
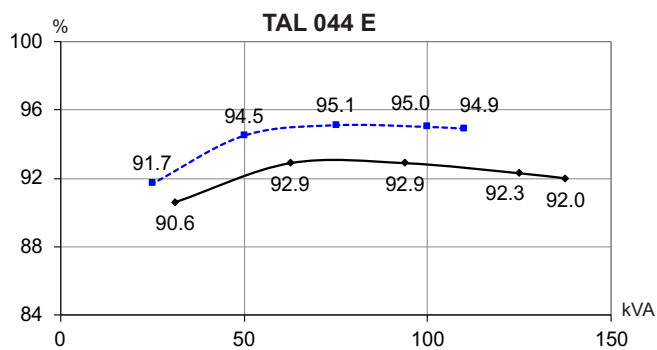
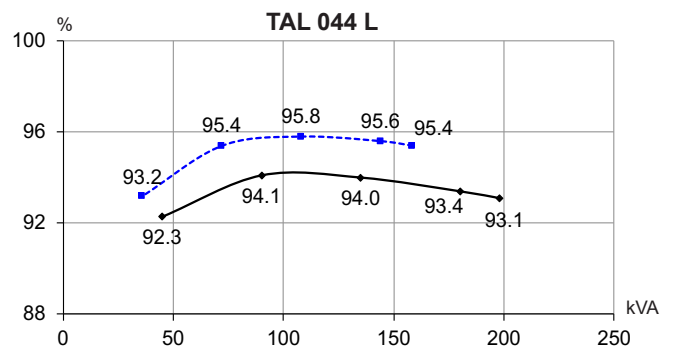
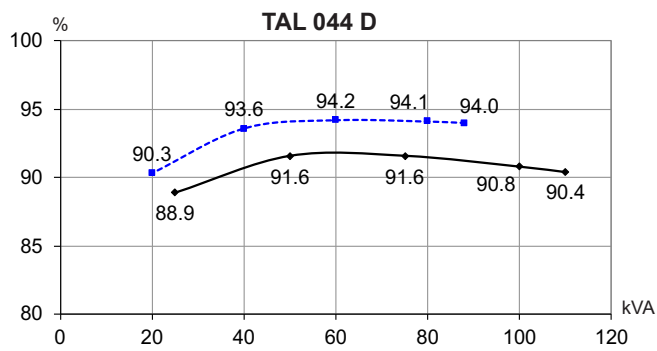
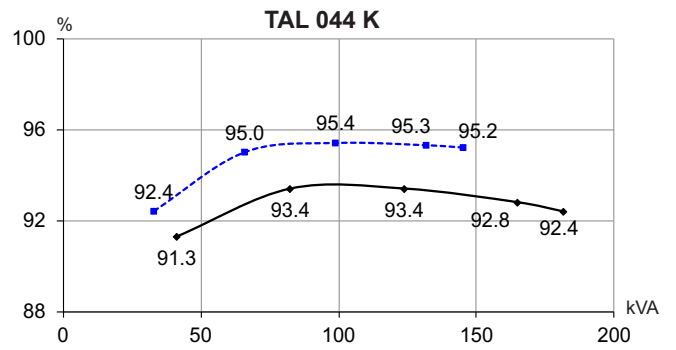
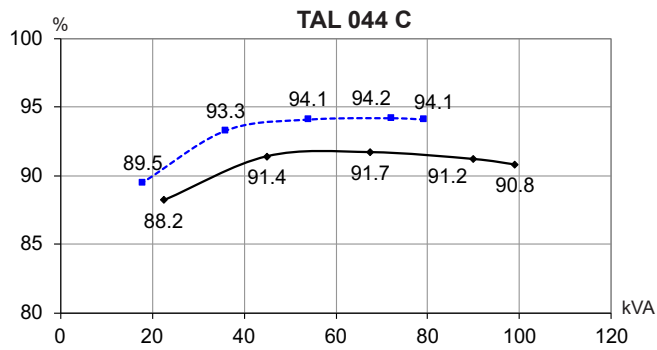
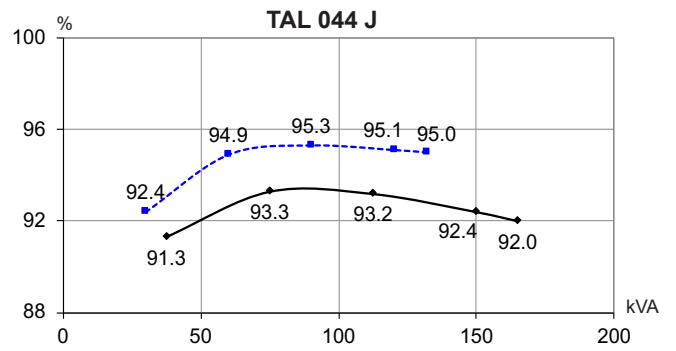
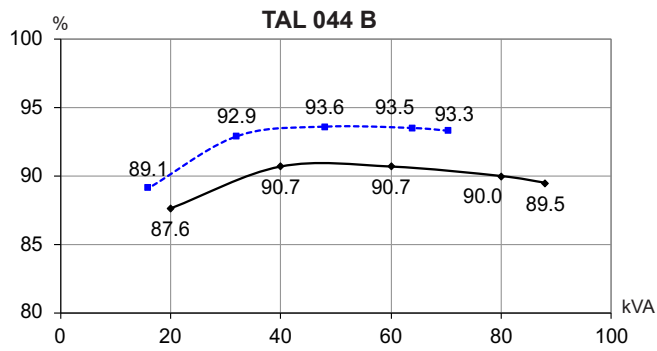
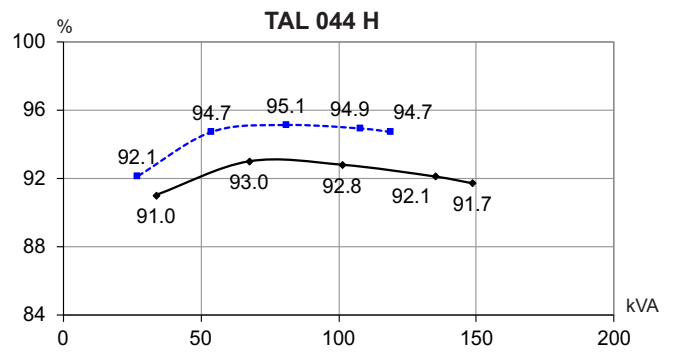
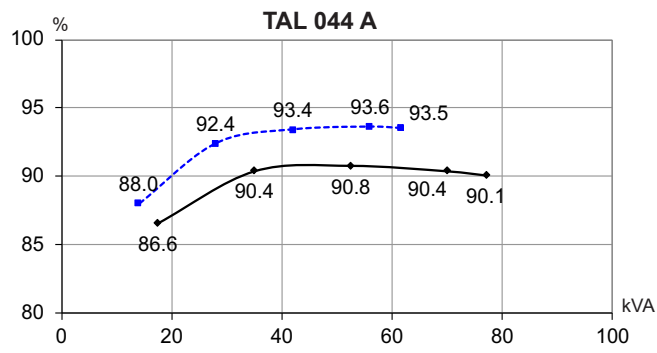

Efficiencies 480 V - 60 Hz (— P.F.: 0.8) (--- P.F.: 1)

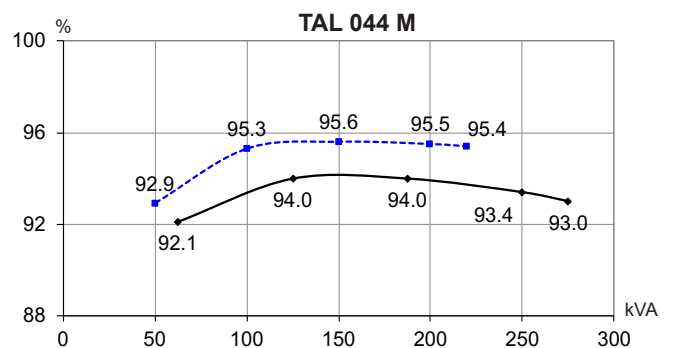
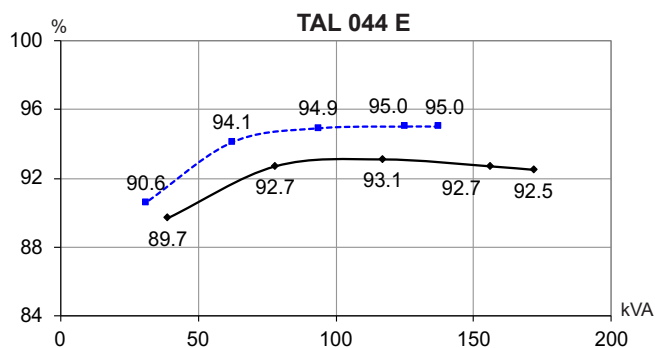
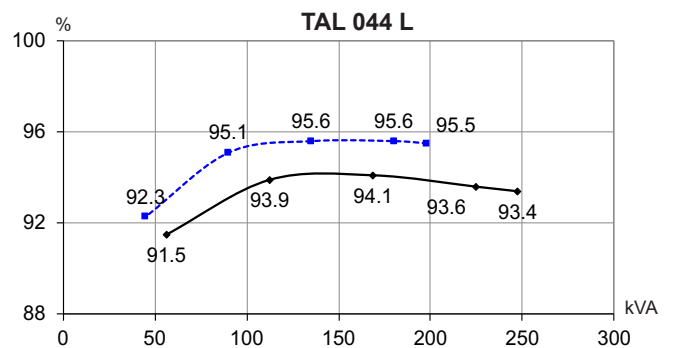
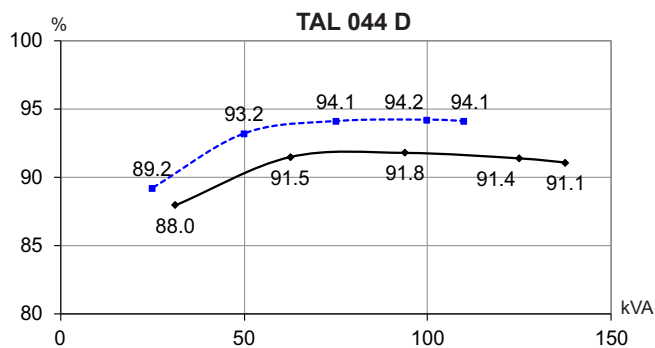
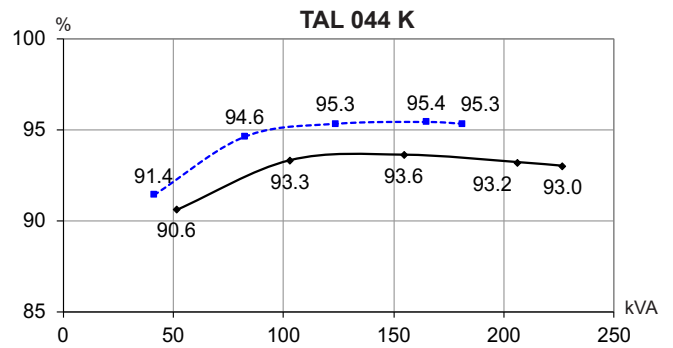
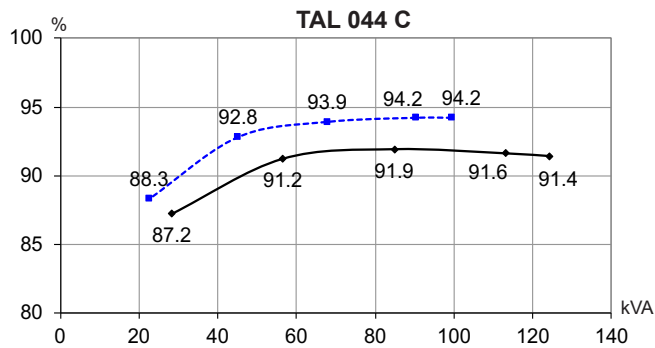
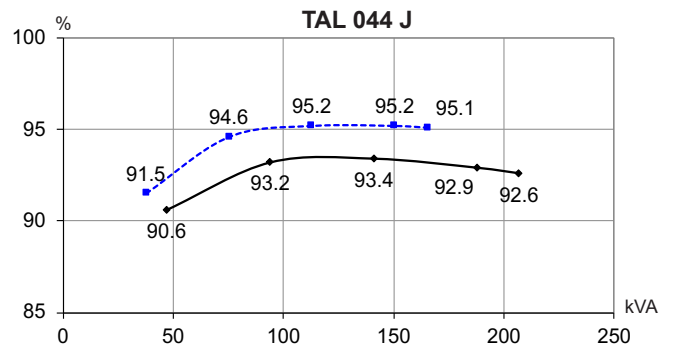
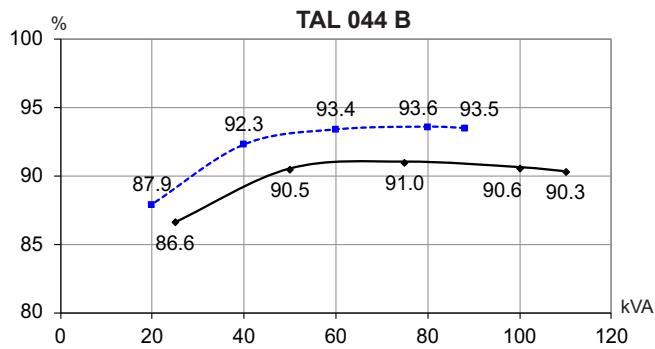
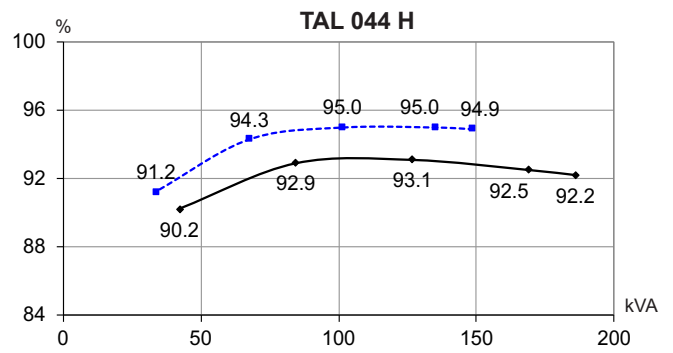
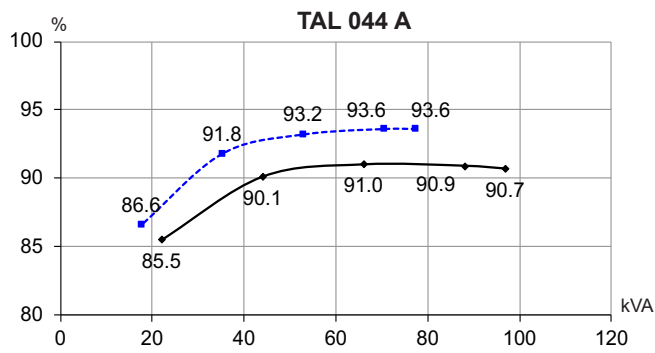

Reactances (%). Time constants (ms) - Class H / 400 V

	A	B	C	D	E	H	J	K	L	M
Kcc Short-circuit ratio	0.57	0.5	0.53	0.48	0.43	0.4	0.4	0.42	0.37	0.33
Xd Direct-axis synchronous reactance unsaturated	294	336	307	341	334	361	359	343	343	381
Xq Quadrature-axis synchronous reactance unsaturated	150	171	156	174	170	184	183	175	175	194
T'do No-load transient time constant	2475	2475	2308	2308	2154	2154	2112	2077	2025	2025
X'd Direct-axis transient reactance saturated	11.9	13.6	13.3	14.7	15.5	16.7	17	16.5	16.9	18.8
T'd Short-circuit transient time constant	100	100	100	100	100	100	100	100	100	100
X''d Direct-axis subtransient reactance saturated	7.1	8.1	7.9	8.8	9.3	10	10.2	9.9	10.1	11.3
T''d Subtransient time constant	10	10	10	10	10	10	10	10	10	10
X''q Quadrature-axis subtransient reactance saturated	16.1	18.3	17	18.9	18.9	20.4	20.4	19.5	19.7	21.9
Xo Zero sequence reactance	0.49	0.56	0.55	0.61	0.64	0.69	0.7	0.68	0.7	0.78
X2 Negative sequence reactance saturated	11.62	13.28	12.53	13.92	14.12	15.25	15.31	14.74	14.96	16.62
Ta Armature time constant	15	15	15	15	15	15	15	15	15	15

Other class H / 400 V data

io (A) No-load excitation current SHUNT	0.84	0.84	0.80	0.80	0.67	0.67	0.66	0.68	0.64	0.64
io (A) No-load excitation current AREP+	1.08	1.08	1.03	1.03	0.87	0.87	0.85	0.88	0.82	0.82
ic (A) On-load excitation current SHUNT	2.60	2.95	2.75	3.08	2.57	2.78	2.79	2.82	2.69	3.01
ic (A) On-load excitation current AREP+	3.35	3.80	3.54	3.96	3.31	3.59	3.60	3.63	3.46	3.88
uc (V) On-load excitation voltage SHUNT	28.9	32.5	30.1	33.2	31.9	34.3	34.1	34.1	20.1	22.2
uc (V) On-load excitation voltage AREP+	23.2	26.1	24.1	26.7	25.6	27.5	27.4	27.4	15.8	17.5
ms Response time ($\Delta U = 20\%$ transient)	500	500	500	500	500	500	500	500	500	500
kVA Start ($\Delta U = 20\%$ cont. or $\Delta U = 30\%$ trans.) SHUNT*	124	124	143	143	204	205	225	254	318	318
kVA Start ($\Delta U = 20\%$ cont. or $\Delta U = 30\%$ trans.) AREP+*	203	203	233	233	333	334	366	413	542	543
% Transient ΔU (on-load 4/4) SHUNT - P.F.: 0.8 _{LAG}	17.2	18.8	18.5	19.9	18.2	19.1	19.3	18.9	17.3	18.6
% Transient ΔU (on-load 4/4) AREP+ - P.F.: 0.8 _{LAG}	12.5	13.6	13.4	14.4	13.2	13.8	13.9	13.7	12.2	13
W No-load losses	1980	1980	2175	2175	2322	2322	2478	2785	2665	2665
W Heat dissipation	5903	7091	6931	8053	8255	9254	9769	10184	10134	11898

* P.F. = 0.6

Reactances (%). Time constants (ms) - Class H / 480 V

	A	B	C	D	E	H	J	K	L	M
Kcc Short-circuit ratio	0.55	0.48	0.5	0.46	0.41	0.38	0.38	0.41	0.36	0.32
Xd Direct-axis synchronous reactance unsaturated	308	350	321	355	348	377	375	356	358	397
Xq Quadrature-axis synchronous reactance unsaturated	157	178	164	181	177	192	191	182	182	202
T'do No-load transient time constant	2475	2475	2308	2308	2154	2154	2112	2077	2025	2025
X'd Direct-axis transient reactance saturated	12.4	14.1	13.9	15.4	16.1	17.5	17.7	17.1	17.6	19.6
T'd Short-circuit transient time constant	100	100	100	100	100	100	100	100	100	100
X''d Direct-axis subtransient reactance saturated	7.4	8.5	8.3	9.2	9.7	10.5	10.6	10.3	10.6	11.7
T''d Subtransient time constant	10	10	10	10	10	10	10	10	10	10
X''q Quadrature-axis subtransient reactance saturated	16.8	19.1	17.8	19.7	19.6	21.3	21.3	20.3	20.5	22.8
Xo Zero sequence reactance	0.51	0.59	0.58	0.64	0.67	0.72	0.74	0.71	0.73	0.81
X2 Negative sequence reactance saturated	12.17	13.83	13.1	14.49	14.69	15.91	15.99	15.34	15.59	17.32
Ta Armature time constant	15	15	15	15	15	15	15	15	15	15

Other class H / 480 V data

io (A) No-load excitation current SHUNT	0.84	0.84	0.79	0.79	0.67	0.67	0.66	0.68	0.63	0.63
io (A) No-load excitation current AREP+	1.08	1.08	1.02	1.02	0.87	0.87	0.85	0.87	0.82	0.82
ic (A) On-load excitation current SHUNT	2.60	2.91	2.72	3.01	2.58	2.79	2.79	2.79	2.69	3.00
ic (A) On-load excitation current AREP+	3.34	3.76	3.51	3.88	3.32	3.59	3.60	3.59	3.47	3.87
uc (V) On-load excitation voltage SHUNT	29.3	32.6	30.3	33.3	32.4	34.8	34.7	34.4	20.4	22.6
uc (V) On-load excitation voltage AREP+	23.5	26.2	24.4	26.7	26	28	27.8	27.6	16.1	17.8
ms Response time ($\Delta U = 20\%$ transient)	500	500	500	500	500	500	500	500	500	500
kVA Start ($\Delta U = 20\%$ cont. or $\Delta U = 30\%$ trans.) SHUNT*	149	150	172	172	246	246	270	304	381	381
kVA Start ($\Delta U = 20\%$ cont. or $\Delta U = 30\%$ trans.) AREP+*	244	244	279	281	401	402	438	498	648	650
% Transient ΔU (on-load 4/4) SHUNT - P.F.: 0.8 _{LAG}	17.7	19.3	19.1	20.4	18.6	19.7	19.9	19.4	17.8	19.1
% Transient ΔU (on-load 4/4) AREP+ - P.F.: 0.8 _{LAG}	12.9	14	13.8	14.7	13.5	14.2	14.3	14	12.5	13.4
W No-load losses	2905	2905	3189	3189	3417	3417	3639	4070	3923	3923
W Heat dissipation	7042	8265	8222	9378	9683	10805	11438	11913	12145	14130

* P.F. = 0.6

Transient voltage variation 400V - 50 Hz

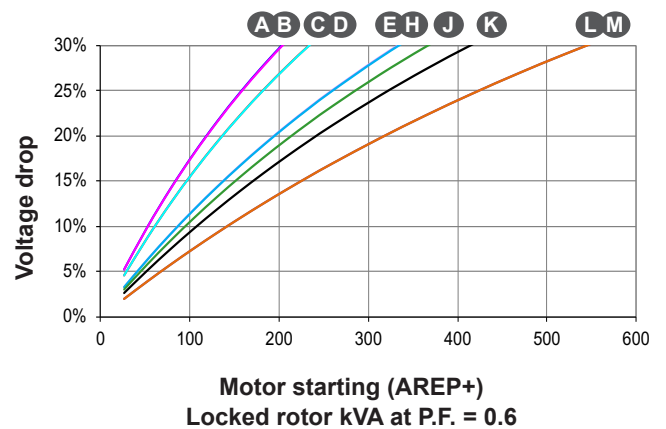
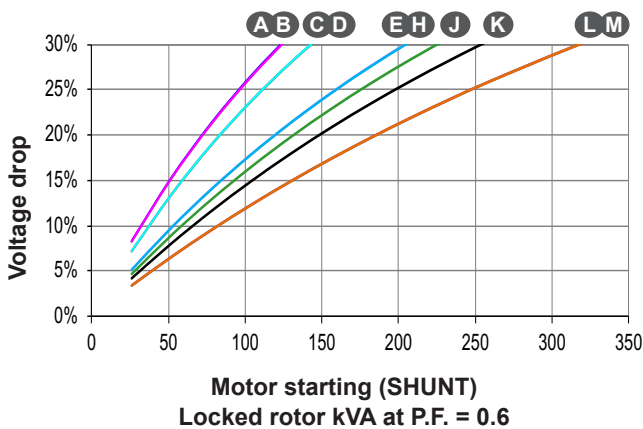
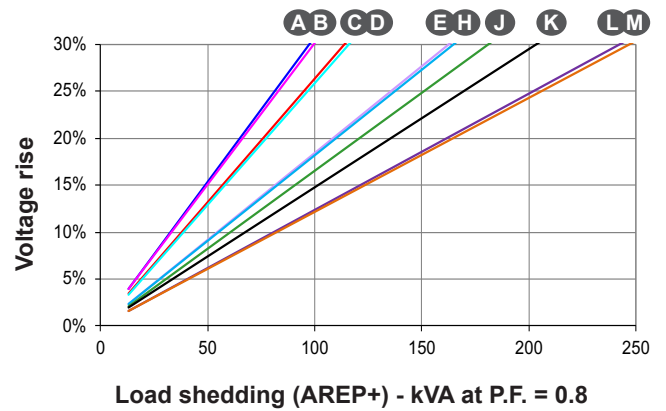
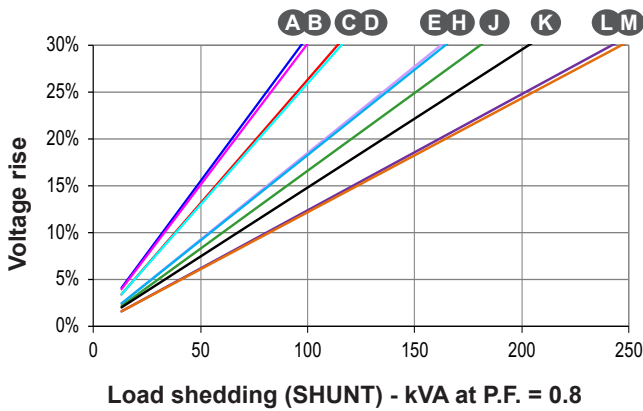
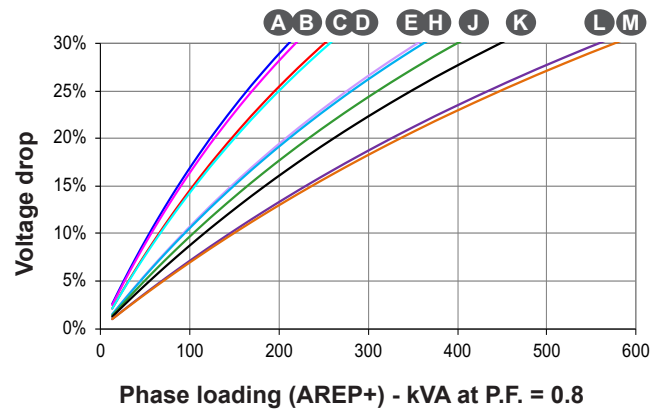
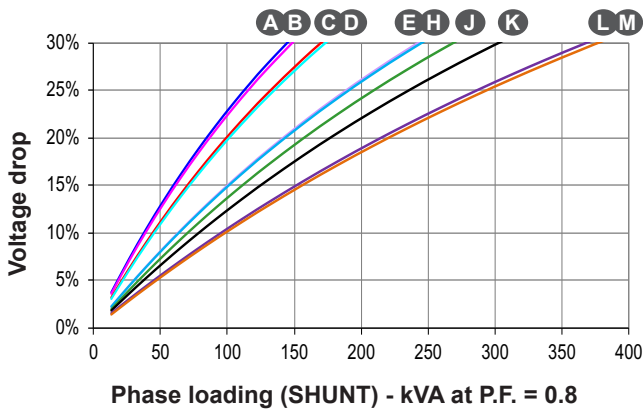

- For a starting P.F. other than 0.6, the starting kVA must be multiplied by $K = \text{Sine P.F.} / 0.8$
- For voltages other than 400V (Y), 230V (Δ) at 50 Hz, then kVA must be multiplied by $(400/U)^2$ or $(230/U)^2$.
- Transient performance of the PMG option, consult us.

Transient voltage variation 480V - 60 Hz

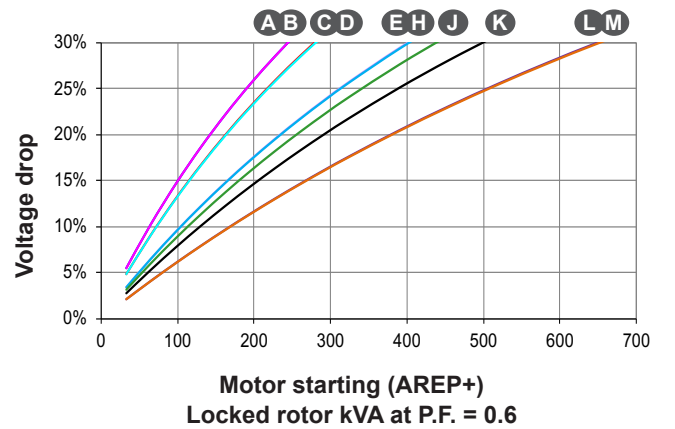
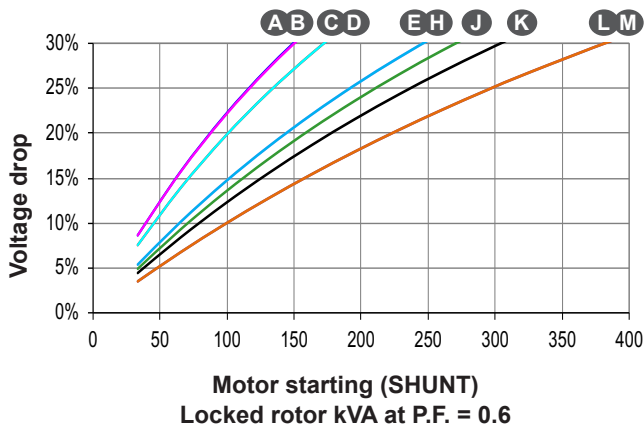
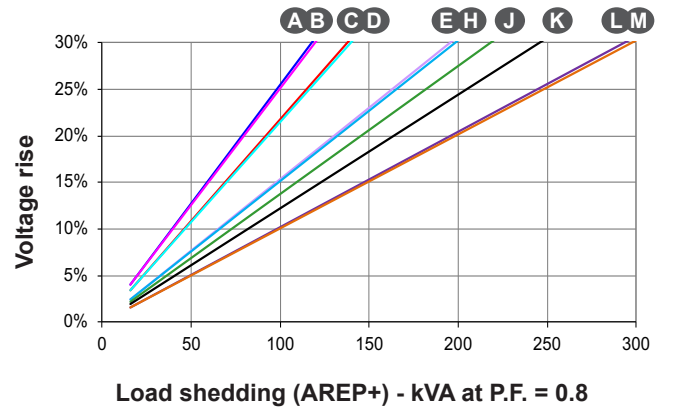
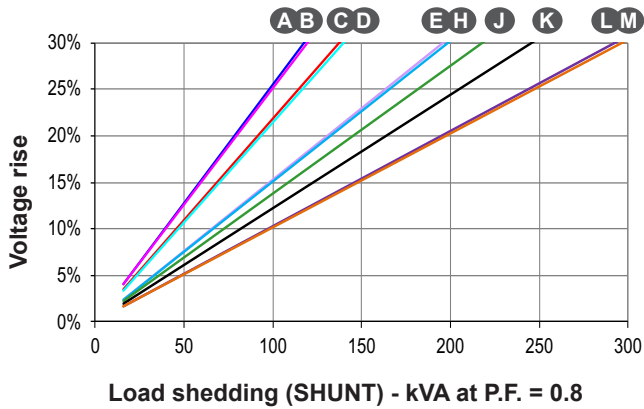
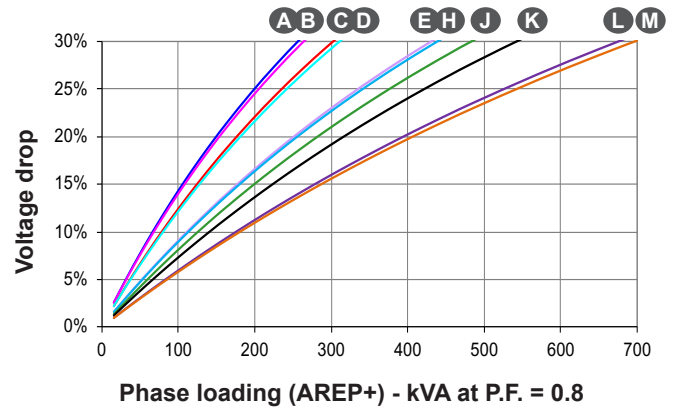
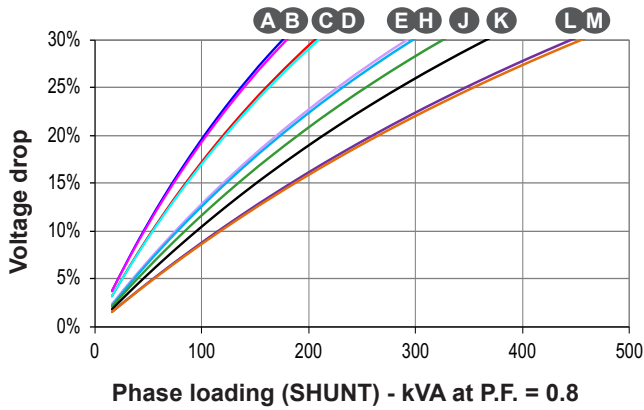

- For a starting P.F. other than 0.6, the starting kVA must be multiplied by $K = \text{Sine P.F.} / 0.8$
- For voltages other than 480V (Y), 277V (Δ), 240V (YY) at 60 Hz, then kVA must be multiplied by $(480/U)^2$ or $(277/U)^2$ or $(240/U)^2$.
- Transient performance of the PMG option, consult us.

3-phase short-circuit curves at no load and rated speed (star connection Y)

TAL 044 A

Symmetrical —
Asymmetrical - - -

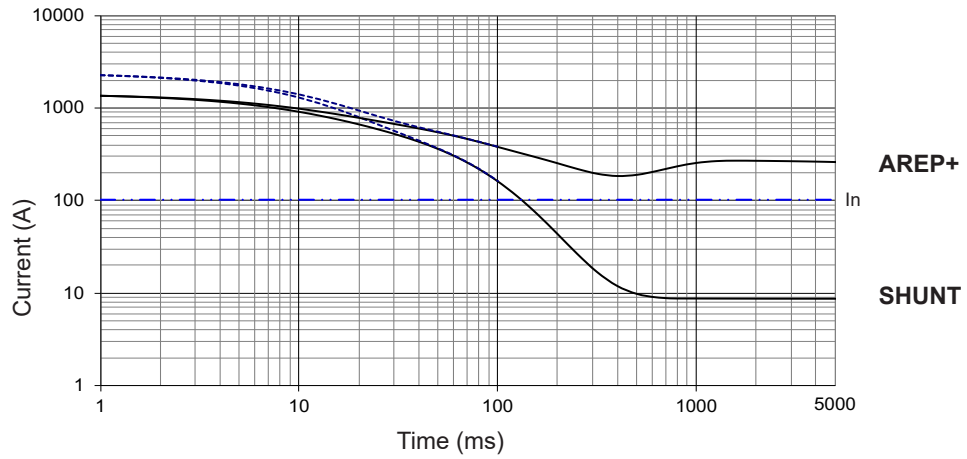

TAL 044 B

Symmetrical —
Asymmetrical - - -

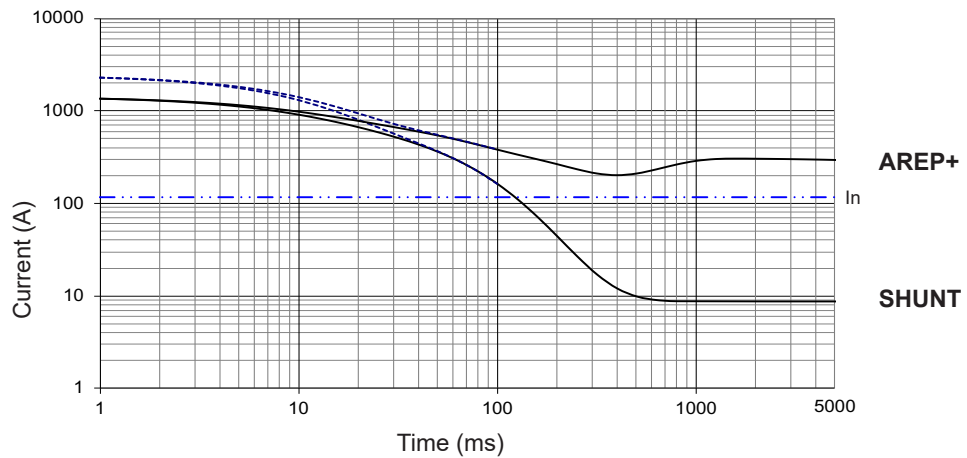

TAL 044 C

Symmetrical —
Asymmetrical - - -

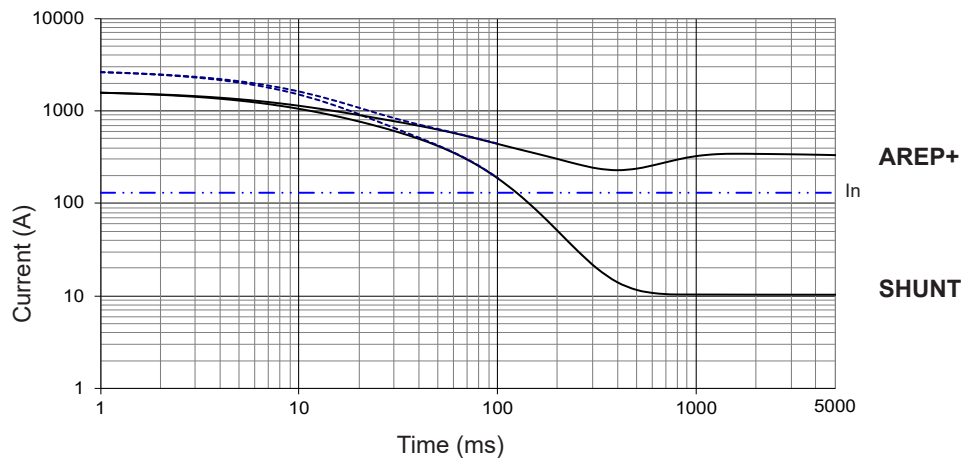

Influence due to connection

For (Δ) connection, use the following multiplication factor:
- Current value x 1.732.

3-phase short-circuit curves at no load and rated speed (star connection Y)

TAL 044 D

Symmetrical —
Asymmetrical - - -

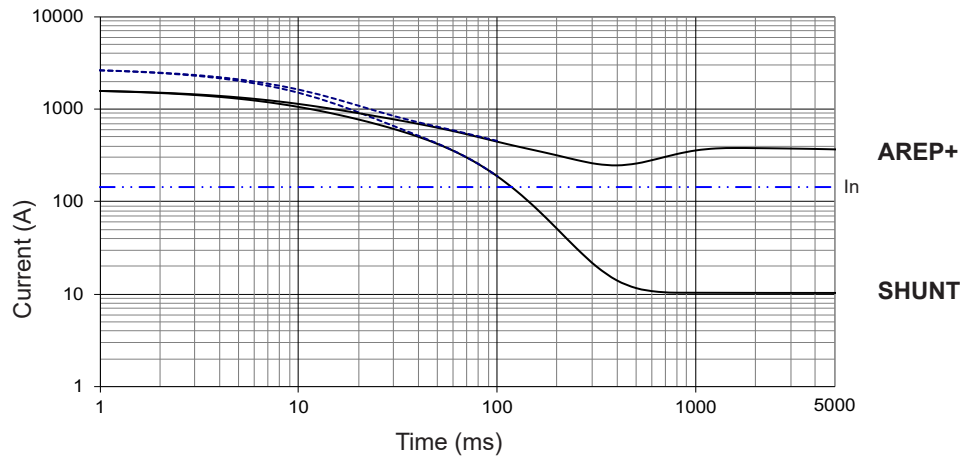

TAL 044 E

Symmetrical —
Asymmetrical - - -

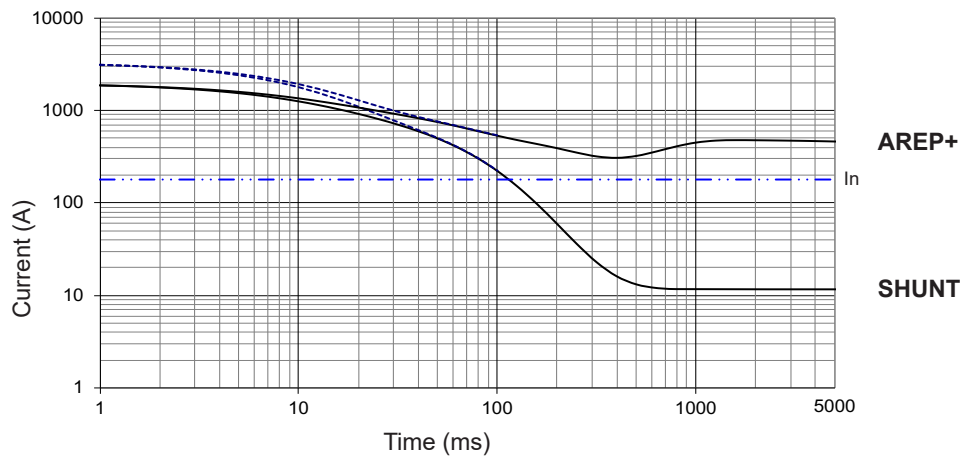

TAL 044 H

Symmetrical —
Asymmetrical - - -

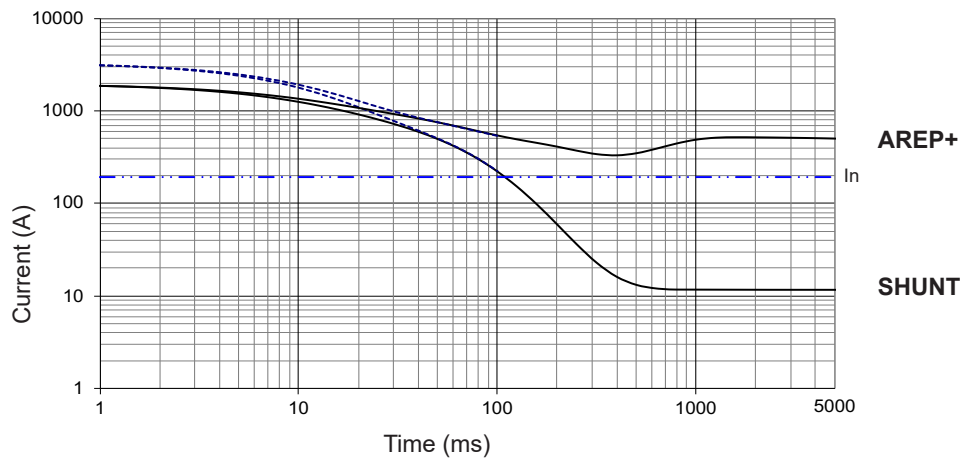

Influence due to short-circuit

Curves are based on a three-phase short-circuit.
For other types of short-circuit,
use the following multiplication factors.

	3 - phase	2 - phase L / L	1 - phase L / N
Instantaneous (max.)	1	0.87	1.3
Continuous	1	1.5	2.2
Maximum duration (AREP+/PMG)		1.5	

3-phase short-circuit curves at no load and rated speed (star connection Y)

TAL 044 J

Symmetrical —
Asymmetrical - - -

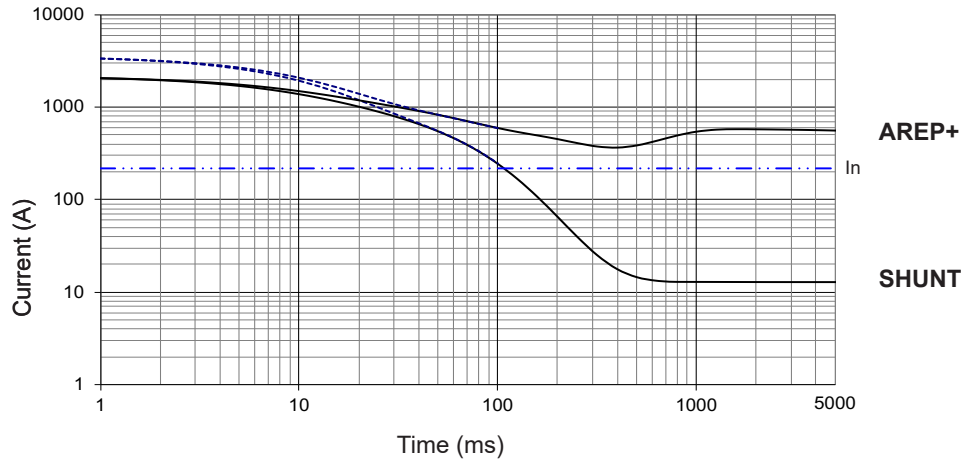

TAL 044 K

Symmetrical —
Asymmetrical - - -

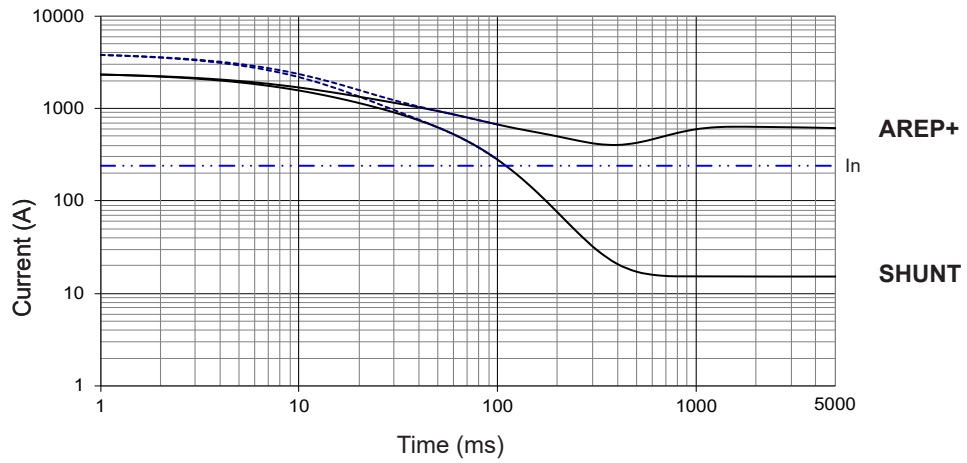

Influence due to connection

For (Δ) connection, use the following multiplication factor:
- Current value x 1.732.

3-phase short-circuit curves at no load and rated speed (star connection Y)

TAL 044 L

Symmetrical —
Asymmetrical - - -

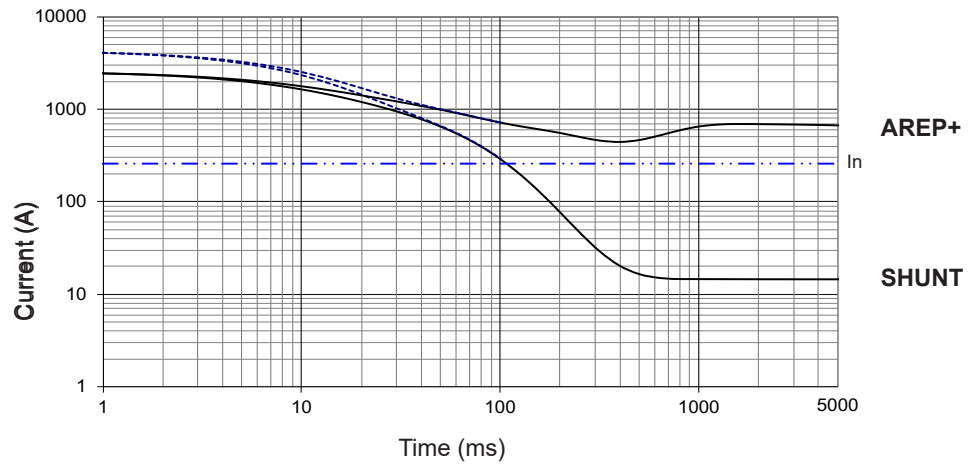

TAL 044 M

Symmetrical —
Asymmetrical - - -

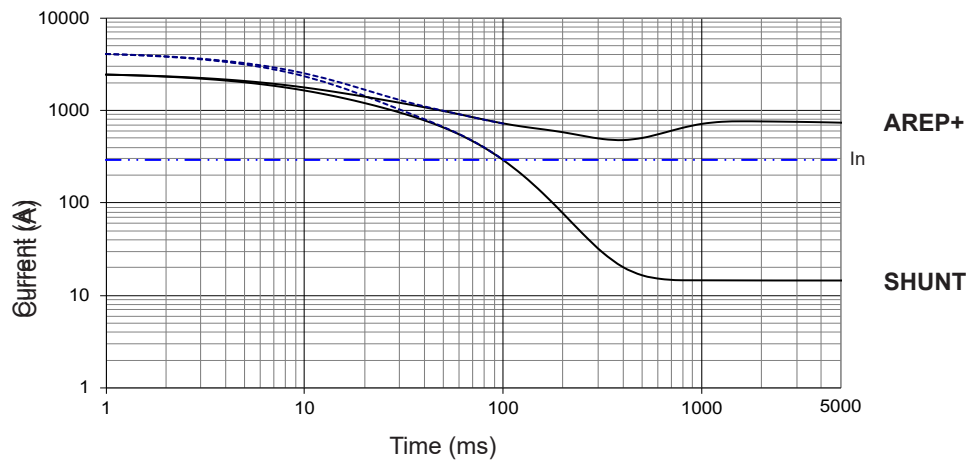

Influence due to short-circuit

Curves are based on a three-phase short-circuit.
For other types of short-circuit,
use the following multiplication factors.

	3 - phase	2 - phase L / L	1 - phase L / N
Instantaneous (max.)	1	0.87	1.3
Continuous	1	1.5	2.2
Maximum duration (AREP+/PMG)		1.5	

TAL 044 - Dedicated single-phase 57 to 82 kVA - 50 Hz / 80 to 125 kVA - 60 Hz

General characteristics

Insulation class	H	Excitation system	SHUNT
Winding pitch	2/3 (wind. M 50 Hz, M1 60 Hz)	AVR type	R121
Number of wires	4	Voltage regulation (*)	± 1 %
Protection	IP 23	Total Harmonic Distortion THD (**) in no-load	< 3.5 %
Altitude	≤ 1000 m	Total Harmonic Distortion THD (**) in linear load	< 5 %
Overspeed	2250 R.P.M.	Waveform: NEMA = TIF (**)	< 100
Air flow	0.25 m ³ /s (50 Hz) / 0.30 m ³ /s (60 Hz)	Waveform: I.E.C. = FHT (**)	< 2 %

(*) Steady state (**) Total harmonic distortion between phases, no-load or on-load (non-distorting)

Ratings / Efficiencies 50 Hz - 1500 R.P.M. - Winding M

kVA / kW - P.F. = 1(*)						
Duty / T° C	Continuous / 40 °C			Stand-by / 40 °C	Stand-by / 27 °C	
Class / T° K	H / 125° K	F / 105° K	H / 150° K	H / 163° K		
Serie (SE) 	230 V	η %	230 V	230 V	230V	η %
TAL 044 C	57	91	52	60	63	90.7
TAL 044 D1	69	91.5	63	73	76	91.1
TAL 044 E	-	-	-	-	-	-
TAL 044 J	82	92.3	75	87	90	92
TAL 044 K	-	-	-	-	-	-

(*) For P.F. 0.8: derating 15%

Ratings / Efficiencies 60 Hz - 1800 R.P.M. - Winding M1

kVA / kW - P.F. = 1(*)						
Duty / T° C	Continuous / 40 °C			Stand-by / 40 °C	Stand-by / 27 °C	
Class / T° K	H / 125° K	F / 105° K	H / 150° K	H / 163° K		
Serie (SE) 	240 V	η %	240 V	240 V	240V	η %
TAL 044 C	80	90	73	85	88	89.7
TAL 044 D1	100	90	91	106	110	89.7
TAL 044 E	115	90.7	105	122	127	90.2
TAL 044 J	-	-	-	-	-	-
TAL 044 K	125	91.7	114	133	138	91.4

(*) For P.F. 0.8: derating 15%

Starting motor 230V - 50Hz

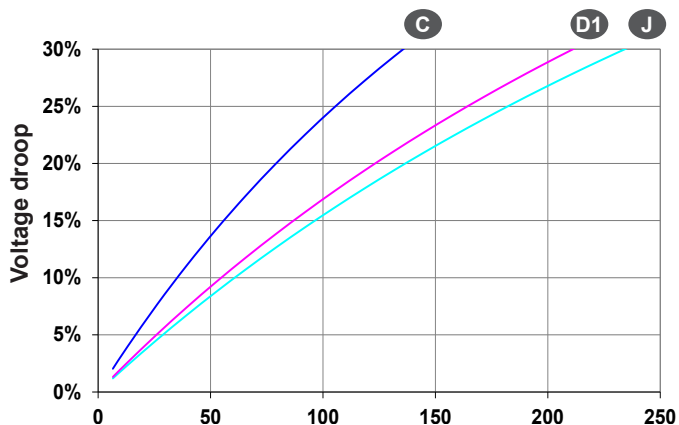

Starting motor 240V - 60Hz

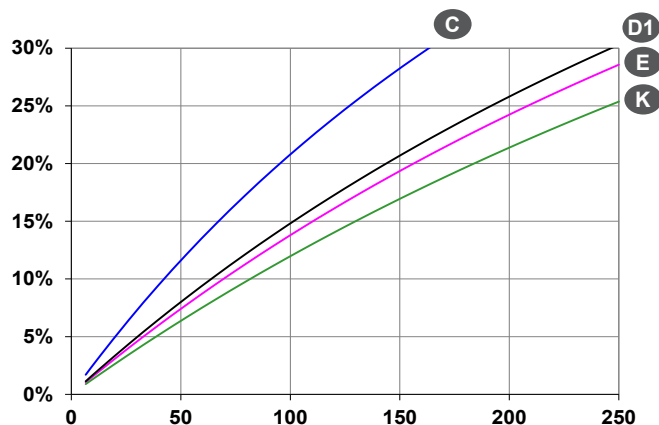

Locked rotor kVA at PF : 0.9

TAL 044 - Three-phase & Single-phase

Single-bearing dimensions

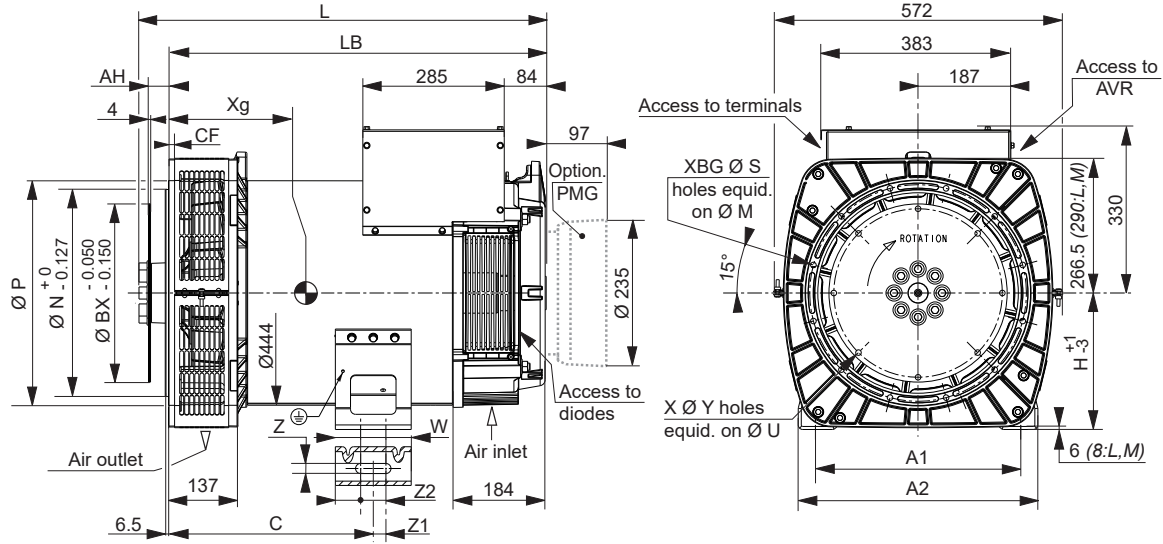

Dimensions (mm) and weight				
Type	L maxi *	LB	Xg	Weight (kg)
TAL 044 A	758	677	293	247
TAL 044 B	758	677	293	247
TAL 044 C	758	677	313	280
TAL 044 D	758	677	313	280
TAL 044 D1	758	677	313	280
TAL 044 E	828	747	353	353
TAL 044 H	828	747	353	353
TAL 044 J	828	747	365	383
TAL 044 K	868	787	383	418
TAL 044 L	953	872	416	539
TAL 044 M	953	872	416	539

* L maxi = LB + AH maxi + 19

Flange (mm)						
S.A.E.	P	N	M	S	XBG	CF
4	400	361.95	381	11	12	16
3	445	409.58	428.62	11	12	16
2	485	447.68	466.72	11	12	16
1	560.5/581*	511.18	530.23	12	10	4.5/10*

* Specific dimension TAL 044 L and M

Shaft height (mm)				Coupling				
H	Standard		Option	Flex plate	1	2	3	4
	270	225*	280**					
C	405	332.5	429	14	x	-	-	-
A1	406	356	457	11 1/2	x	x	x	-
A2	474	430	541	8	-	-	x	x
Z	20	14.5	20					
Z1	25	20	25					
Z2	50	40	50					
W	150	120	150					

* Not available for L and M

** Available only for L and M

Flex plate (mm)					
S.A.E.	BX	U	X	Y	AH
14	466.72	438.15	8	14	25.4
11 1/2	352.42	333.38	8	11	39.6
10	314.32	295.28	8	11	53.8
8	263.52	244.48	6	11	62

Torsional analysis data

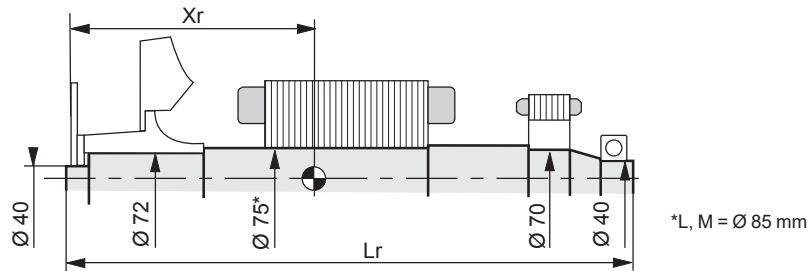

Centre of gravity: Xr (mm), Rotor length: Lr (mm), Weight: M (kg), Moment of inertia: J (kgm²): (4J = MD²)																
Flex plate	S.A.E. 8				S.A.E. 10				S.A.E. 11 1/2				S.A.E. 14			
	Xr	Lr	M	J	Xr	Lr	M	J	Xr	Lr	M	J	Xr	Lr	M	J
TAL 044 A	352.4	727	107.1	0.739	362.4	719	107.2	0.753	349.3	704	106.8	0.769	298.6	711	113.8	0.899
TAL 044 B	352.4	727	107.1	0.739	362.4	719	107.2	0.753	349.3	704	106.8	0.769	298.6	711	113.8	0.899
TAL 044 C	362.5	727	120.9	0.863	353.2	719	121.0	0.877	340.3	704	120.6	0.893	310.0	711	127.6	1.023
TAL 044 D	362.5	727	120.9	0.863	353.2	719	121.0	0.877	340.3	704	120.6	0.893	310.0	711	127.6	1.023
TAL 044 D1	362.5	727	120.9	0.863	353.2	719	121.0	0.877	340.3	704	120.6	0.893	310.0	711	127.6	1.023
TAL 044 E	408.5	797	153.6	1.137	398.5	789	153.7	1.151	385.4	774	153.3	1.167	357.3	781	160.2	1.297
TAL 044 H	408.5	797	153.6	1.137	398.5	789	153.7	1.151	385.4	774	153.3	1.167	357.3	781	160.2	1.297
TAL 044 J	419.4	797	165.4	1.244	409.3	789	165.5	1.258	396.2	774	165.1	1.274	368.8	781	172.0	1.404
TAL 044 K	439.4	837	180.7	1.379	429.2	829	180.8	1.393	416.0	814	180.4	1.409	389.2	821	187.4	1.539
TAL 044 L	480.9	922	221.1	1.713	471.3	914	221.2	1.727	458.3	899	220.8	1.743	449.6	906	227.8	1.873
TAL 044 M	480.9	922	221.1	1.713	471.3	914	221.2	1.727	458.3	899	220.8	1.743	449.6	906	227.8	1.873

NOTE : Dimensions are for information only and may be subject to modifications. The torsional analysis of the transmission is imperative. All values are available upon request.

LEROY-SOMER[™]

www.leroy-somer.com/epg

[Linkedin.com/company/leroy-somer](https://www.linkedin.com/company/leroy-somer)
[Twitter.com/Leroy_Somer_en](https://twitter.com/Leroy_Somer_en)
[Facebook.com/LeroySomer.Nidec.en](https://www.facebook.com/LeroySomer.Nidec.en)
[YouTube.com/LeroySomerOfficiel](https://www.youtube.com/LeroySomerOfficiel)



Nidec
All for dreams

© 2022 Moteurs Leroy-Somer SAS. The information contained in this brochure is for guidance only and does not form part of any contract. The accuracy cannot be guaranteed as Moteurs Leroy-Somer SAS have an ongoing process of development and reserve the right to change the specification of their products without notice.

Moteurs Leroy-Somer SAS. Headquarters: Bd Marcellin Leroy, CS 10015, 16915 Angoulême Cedex 9, France. Share Capital: 38,679,664 €, RCS Angoulême 338 567 258.